

AOK *iC* Series
New LED Canopy Light



Overview

- √ Specilized designed for gas station, warehouse, office, church, etc;
- √ Supporting recessed or surface mount installation style;
- √ System luminous efficacy >130lm/w, lifespan >50,000 hours;
- √ Super slim design;
- √ Fit with the hole in different dimensions.

**iC Series Type A -
American Recessed Kit**



**iC Series Type B -
Common Recessed Kit**



**iC Series Type C -
Australian Recessed**



**iC Series Type D -
Surface Mounted Kit**

The new iC series LED canopy light is just another brilliant outcome of AOK's R&D in 2015. This light is a perfect solution for the areas gas station or warehouse. It can be recessed into the roof or surface mounted on the roof, and it even has more than one way of recess.

For a long time, the basic problem of LED canopy light is how to fit with the existing holes on the roof of the gas station. Now the AOK iC series providing easy and convenient ways to achieve this task.

The new iC series is from 75W to 150W, can replace up to 480W traditional luminaire.

AOK-75WiC

LED Canopy Light, 200-250W HPS/MH Replacement



1-10V / PWM / Resistance dimming optional

Specifications

Electrical Specifications

Model No.	AOK-75WiC
Nominal Wattage	75W
Nominal Voltage	90-305VAC, 50/60Hz 277-480VAC, 50/60Hz
Maximum Current	AC 0.85A (max)
Power Factor (PF)	>0.95
Driver Efficiency	>92%

Photometric Specifications

Luminous Flux	+Lumen tolerance +/- 5% 9,750lm
CRI	Ra>78
CCT	3000-6500K
Optional Beam Angle	60° / 120° / 90°*100°

Mechanical Specifications

IP&IK Rating	IP66 & IK10
Lifetime	50000 hours - L70, @25°C
Heat Radiator	Anodized Aluminum
Lens	PC
Fixture Dimension	420*420*100mm 15.7*10.7*3.9 inches
Net Weight	4.8kg
Carton Dimension	480*320*200mm
Gross Weight	5.7kg

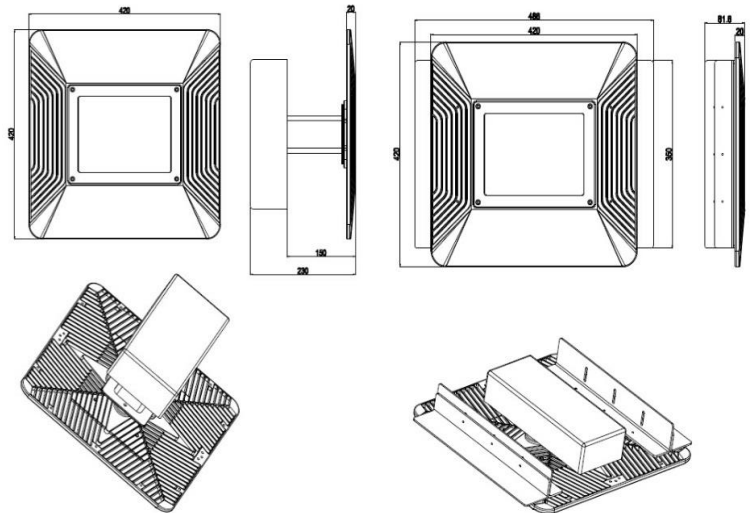

420*420mm
Recessed
Installation Style A

420*420mm
Recessed
Installation Style B

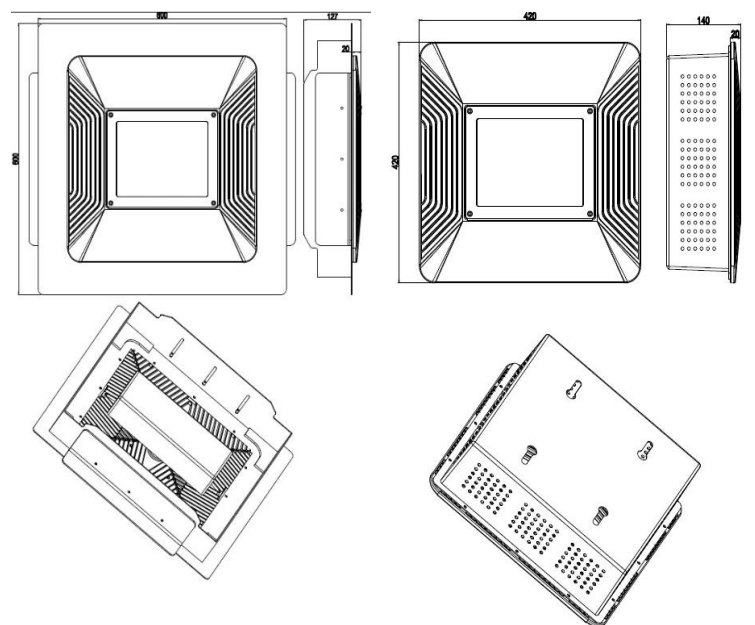

600*600mm
Surface Mounted
Installation Style C

420*420mm
Surface Mounted
Installation Style D

AOK-110WiC

LED Canopy Light, 300-350W HPS/MH Replacement



New



1-10V / PWM / Resistance dimming optional

Specifications

Electrical Specifications

Model No.	AOK-110WiC
Nominal Wattage	110W
Nominal Voltage	90-305VAC, 50/60Hz 277-480VAC, 50/60Hz
Maximum Current	AC 1.25A (max)
Power Factor (PF)	>0.95
Driver Efficiency	>93%

Photometric Specifications

Luminous Flux	+Lumen tolerance +/- 5% 14,300lm
CRI	Ra>78
CCT	3000-6500K
Optional Beam Angle	60° / 120° / 90°*100°

Mechanical Specifications

IP&IK Rating	IP66 & IK10
Lifetime	50000 hours - L70, @25°C
Heat Radiator	Anodized Aluminum
Lens	PC
Fixture Dimension	420*420*100mm 15.7*10.7*3.9 inches
Net Weight	5kg
Carton Dimension	480*320*200mm
Gross Weight	6kg

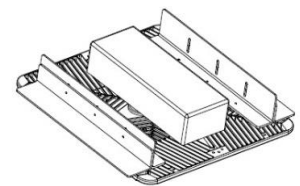
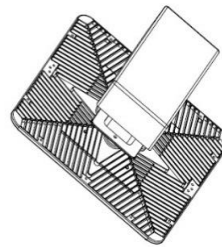
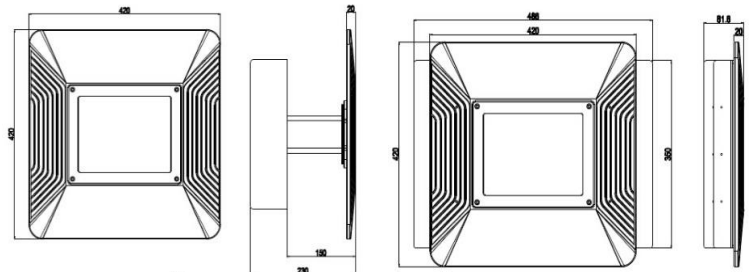

420*420mm
Recessed
Installation Style A

420*420mm
Recessed
Installation Style B

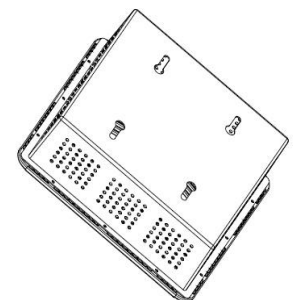
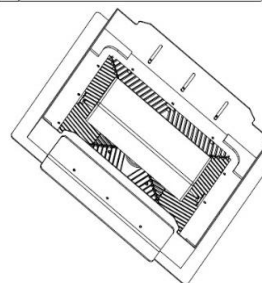
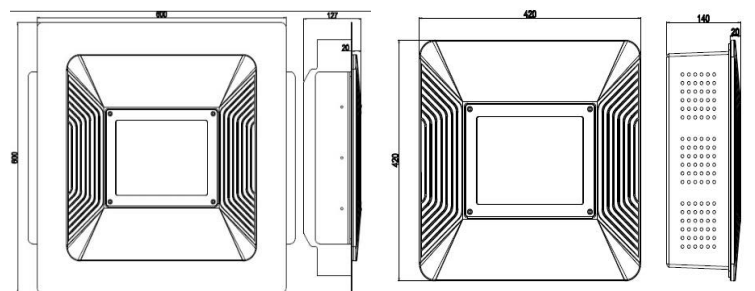

600*600mm
Surface Mounted
Installation Style C

420*420mm
Surface Mounted
Installation Style D

AOK-150WiC

LED Canopy Light, 400-480W HPS/MH Replacement



New



1-10V / PWM / Resistance dimming optional

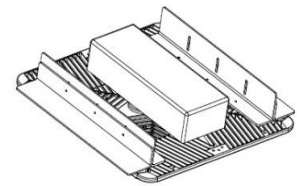
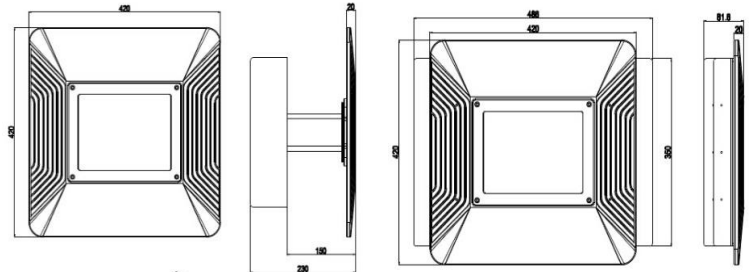

420*420mm
Recessed
Installation Style A

420*420mm
Recessed
Installation Style B

Specifications

Electrical Specifications

Model No.	AOK-150WiC
Nominal Wattage	150W
Nominal Voltage	90-305VAC, 50/60Hz 277-480VAC, 50/60Hz
Maximum Current	AC 1.67A (max)
Power Factor (PF)	>0.95
Driver Efficiency	>93%

Photometric Specifications

Luminous Flux	+Lumen tolerance +/- 5% 19,500lm
CRI	Ra>78
CCT	3000-6500K
Optional Beam Angle	60° / 120° / 90°*100°

Mechanical Specifications

IP&IK Rating	IP66 & IK10
Lifetime	50000 hours - L70, @25°C
Heat Radiator	Anodized Aluminum
Lens	PC
Fixture Dimension	420*420*100mm 15.7*10.7*3.9 inches
Net Weight	5kg
Carton Dimension	480*320*200mm
Gross Weight	6.2kg

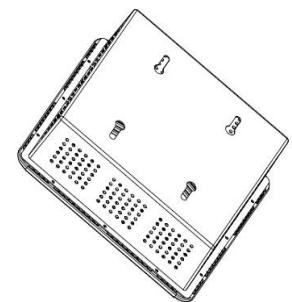
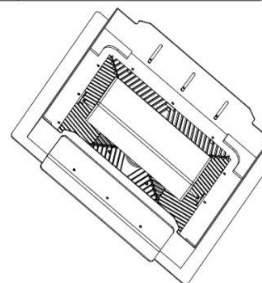
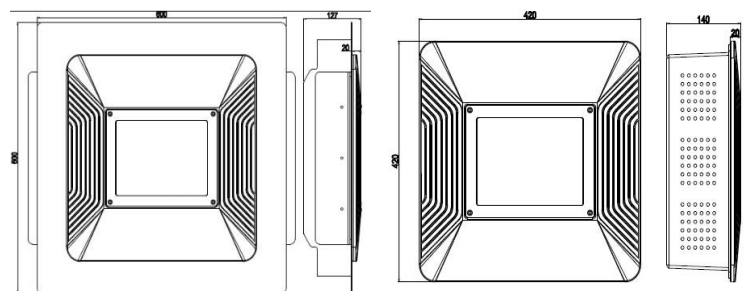

600*600mm
Surface Mounted
Installation Style C

420*420mm
Surface Mounted
Installation Style D